

CATALOGUE

1. FEATURE INTRODUCTION.....	2
2. PARTS LIST.....	3
3. SYSTEM ASSEMBLY.....	3
4. SYSTEM OPERATION.....	4
5. SYSTEM SETTING.....	5
6. COIN AND CREDIT VALUE SETTING TABLE.....	5
7. SYSTEM FUNCTION SETTING TABLE.....	5
8. VIDEO OUTPUT MODE SETTING.....	5
9. GAME LIST HIDE/SHOW.....	6
10. SAVE MODIFIED GAME LIST.....	8
11. ONE GAME BUSINESS MODE.....	9
12. DELETE GAME FROM GAME LIST.....	9
13. ADD GAMES FROM ALL GAME LIST TO ONE OF GAME LISTS.....	10
14. LANGUAGE SETTING.....	11
15. NEW GAMES UPDATE.....	12
16. GAME CONFIGURATION SETTING.....	12
Type 1: Original setting is on screen setting mode.....	12
SAVE MODIFIED GAME CONFIGURATION SETTING.....	13
Type 2: Original setting is DIP SW setting mode.....	14
Type 3: Special setting mode.....	15
17. CHANGE 2P or 4P PLAY MODE.....	17
18. TROUBLE SHOOTING.....	17
19. GAMES FAMILY HARD DISC DATA RETRIEVE.....	18
20. JAMMA CONNECTOR PIN OUT DEFINITION.....	19

GAMES FAMILY USER MANUAL (4P)

Thank you for purchasing this product. For your convenient to understand this system operation, we hope you read this manual detail.

FEATURE INTRODUCTION:

1. Protect JAMMA I/O from damage of incorrect connection
2. Use P4 motherboard, Intel Celeron4 CPU, Hard Disc, 256M DDR.
3. Installed multi game emulators software.
4. Allow coins inserted before game selection.
5. After power on player can insert coin at any time
6. Support 4 people play mode.
7. Support one game / multi games business mode.
8. Support 3D games.
9. Support video mode: VGA (31KHZ), NTSC (15KHZ), PAL (15KHZ), SEGA (24KHZ).
10. Support two-channel stereo audio.
11. Faster I/O response and more stable system operation.
12. Classified all games to Stage, Flying/Shooting, Wrestle/Fighting, Maze/Puzzle, Adult, Sport, Misc./Others, and Special/Classical game list.
13. Each game list can be hided or showed.
14. Each game in list can be deleted or called back.
15. Support simple Chinese and English.
16. Game configurations are adjustable.
17. Support coin counter.
18. Set all games coin and credit value by one DIP SW.
19. One touch key can retrieve data automatically when Hard Disc data lost.
20. Support new games update.

JAMMA CONNECTOR PIN OUT DEFINITION:

SOLID SIDE		PART SIDE	
GND	A	1	GND
GND	B	2	GND
+5V	C	3	+5V
+5V	D	4	+5V
N · C ·	E	5	N · C ·
+12V	F	6	+12V
KEY NO PIN	H	7	KEY NO PIN
N · C ·	J	8	COIN COUNTER
N · C ·	K	9	N · C ·
RIGHT SPEAKER	L	10	LEFT SPEAKER
GND	M	11	N.C.
VIDEOGREEN	N	12	VIDEO RED
VIDEO SYNC	P	13	VIDEO BLUE
N.C.	R	14	N.C.
N.C.	S	15	N.C.
COIN 2	T	16	COIN 1
2P START	U	17	1P START
2P UP	V	18	1P UP
2P DOWN	W	19	1P DOWN
2P LEFT	X	20	1P LEFT
2P RIGHT	Y	21	1P RIGHT
2P SHOOT 1	Z	22	1P SHOOT 1
2P SHOOT 2	a	23	1P SHOOT 2
2P SHOOT 3	b	24	1P SHOOT 3
2P SHOOT 4	c	25	1P SHOOT 4
2P SHOOT 5	d	26	1P SHOOT 5
GND	e	27	GND
GND	f	28	GND

next power on.

A: After mode changed, please excuse any game and then exit from the game to the game list.

Q: When connected 2 machines for 4 people playing, one of the chassis always be destroyed, why?

A: Please install transformer into machine to isolate A.C. power of chassis with another one.

GAMES FAMILY HARD DISC DATA RETRIEVE

1. Connect hard disc(data lost) to IDE2 port of GAMES FAMILY mainframe and connect power to hard disc. (Figure 45)
2. Set bit 4 of SW2 at ON position.
3. After turn ON cabinet power, click 2P START button immediately until the Ghost clone program display on screen, system will proceed data retrieve procedure automatically. (It's on VGA mode. To monitor the procedure, please connect VGA monitor.)
4. Around 20 minutes later, system will complete clone procedure and shut down automatically.
5. Remove IDE2 hard disc and set bit 4 of SW2 at OFF position and proceeds as normal.

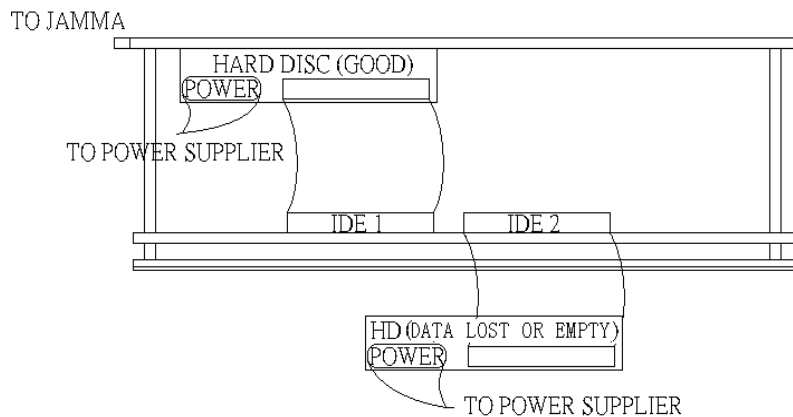

(Figure 45)

PARTS LIST:

1. Games Family mainboard. (Double deck).
2. 3&4p connector board with a Cable wire.
3. A/V wires. (8 wires for 3&4P audio and video input).
4. 5 line wires. (For 1P&2P shooting button 5th & 6th).
- ~~5. ATX power supplier with an AC power wire.~~
6. User manual.

Suggestion: If you need to deliver this product to your customer please mind keeping the cushion package box complete to avoid the HARD DISC damaged.

SYSTEM ASSEMBLY:

1. Finish each parts connection as the picture below (Figure 1):

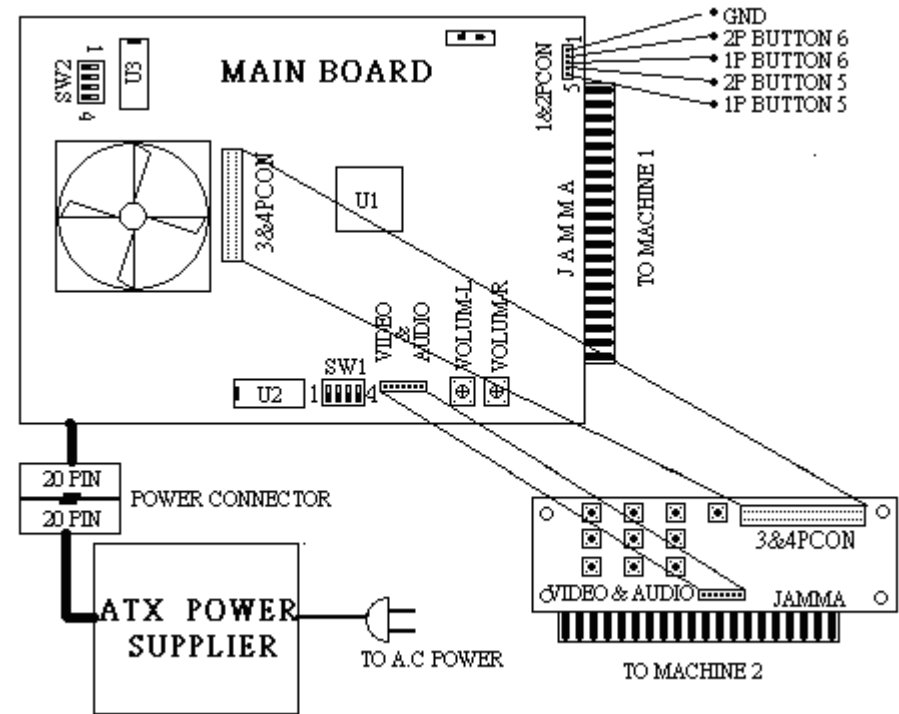

(Figure 1)

Warning: Use a wrong A.C. power input or connect the mainboard with JAMMA slot opposite direct would destroy power supplier or mainboard seriously.

2. Two channel stereo audio circuit (Figure 2):

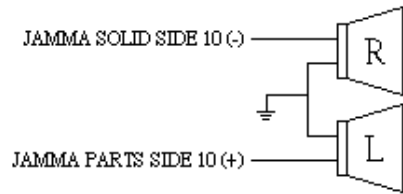

TWO CHANNEL STEREO AUDIO CIRCUIT

(Figure 2)

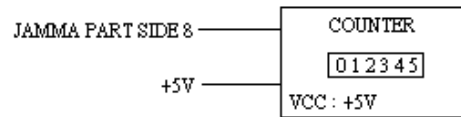

(Figure 2.1)

3. Counter connect circuit (Figure 2.1)

SYSTEM OPERATION:

1. Switch on machine power and ATX Power Supplier (DO NOT press switch bottom of mainboard. The system will start automatically in 3 seconds). After 90 seconds game list will shows on screen
2. Insert coins first and than select game. (It also could be adjusted to insert coins after game select. Please see SYSTEM FUNCTION SETTING TABLE on page 5.)
3. Select game name by moving 1P joystick. Press 1P Start Button to start game mode.
4. Escape from game mode to game list by pressing 1P Start Button (or pressing 1P start and A button, Please see SYSTEM FUNCTION SETTING TABLE on page 5.) for 3 seconds.
5. Change game list by pressing 1P button A or B.

10. Operate step 6 to 11 on page 13 for saving the game configuration setting (Figure 33).

CHANGE 2P or 4P PLAY MODE:

1. Switch ON bit 4 of SW2 (Figure 3).
2. Press MODE key (Figure 28) to change 2P or 4P mode.
3. Switch OFF bit 4 of SW2 (Figure 3).
4. enter any game and play once then exit from the game to the game list ,It will save the setting.

TROUBLE SHOOTING

Q & A:

Q: Pressed 1P START button for 3 seconds, also can't back to game list.

A: Switch off SW2 bit 4 and bit 3.

Q: 3&4P connector board doesn't work.

A: Switch ON SW2 bit4.

Q: System can start but can't entry game mode.

A: Execute "GAMES FAMILY HARD DISC DATA RETRIEVE" on page 18.

Q: After power on around 2 minutes, the picture still got messy (no synchronous).

A: It might be got a **unbefitting** video output mode, please change video output mode to **PAL** or NTSC. (See page 6 "VIDEO OUTPUT MODE SETTING".)

Q: During 3P and 4P are playing, video mode always be changed.

A: Check bit 4 of SW2 whether it's set at ON position, please set it at OFF position after corrected video output mode.

Q: After power on, press the switch bottom of mainboard, system can't start and the fan have no rotation.

A: After switch machine power on, DO NOT press switch bottom of mainboard. The system will start automatically in 3 seconds.

Q: Changed 2p or 4p playing mode but can't keep playing mode after

2. Select the game that will be set (Ex. Tank Force) and start the game (Figure 40).
3. Press ADJ2 (Figure 28).
4. Select “Dip Switches” item (Figure 40) and press 1P START button.



(Figure 41)



(Figure 42)

5. Select “Service Mode” item and set “On” by moving 1P joystick left or right (Figure 41).
6. Press ADJ2 key (Figure 28) to close the current setting window and modify configuration setting by 1P joystick (Figure 42).
7. After finished all configurations setting, press ADJ2 key (Figure 28) and set “Service Mode” Off (Figure 43).

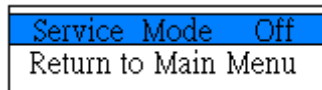

(Figure 43)



(Figure 44)

8. Press ADJ2 key (Figure 28) to delete the small setting window (Figure 44).
9. Press ESC key (Figure 28) to back to game list (Figure 29).

SYSTEM SETTING

COIN AND CREDIT VALUE SETTING TABLE:

SW1:

COIN	CREDIT	SW1		
		4	2	1
1 COIN	1 CREDIT	OFF	OFF	OFF
1 COIN	2 CREDITS	ON	OFF	ON
1 COIN	3 CREDITS	ON	ON	OFF
1 COIN	4 CREDITS	ON	ON	ON
2 COINS	1 CREDIT	OFF	OFF	ON
3 COINS	1 CREDIT	OFF	ON	OFF
4 COINS	1 CREDIT	OFF	ON	ON

(TABLE 1)

SYSTEM FUNCTION SETTING TABLE

FUNCTION		SWITCH POSITION			
		4	3	2	1
GAME MODE		OFF			
SETTING MODE		ON			
MULTY GAME MODE			OFF		
SINGLE GAME MODE			ON		
EXIT OPERATION	PRESS 1P START BUTTON ONLY			OFF	
	PRESS 1P START AND BUTTON A			ON	
INSERT COINS	BEFORE GAME SELECT				OFF
	AFTER GAME SELECT				ON

(TABLE 2)

VIDEO OUTPUT MODE SETTING:

1. Switch ON bit 4 of SW2 (Figure 3).

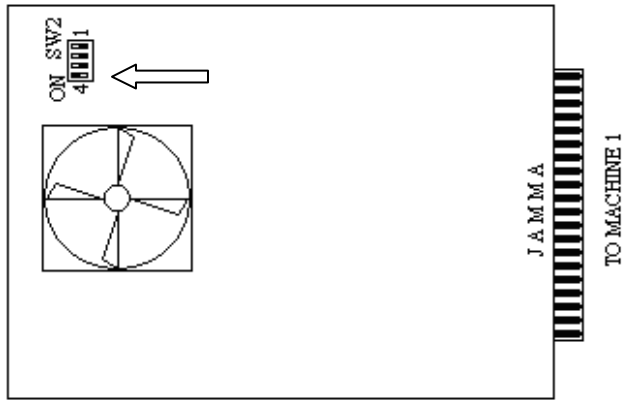

(Figure 3)

1. Press VIDEO key (Figure 4), video output mode will be changed as below:

VGA → NTSC → PAL → SEGA → VGA

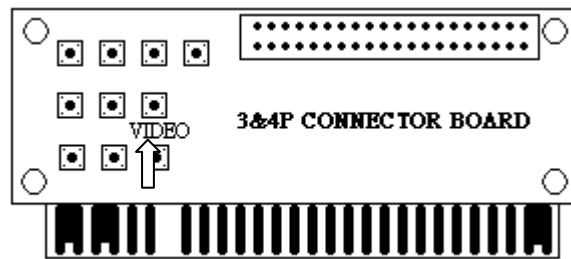

(Figure 4)

2. Switch OFF bit 4 of SW2.

GAME LIST HIDE/SHOW

1. Switch ON bit 4 of SW2 (Figure 3).



(Figure 5)

(Figure 37). Select setting item or modify setting by moving 1P joystick left or right (Figure 37).

5. After setting modified, select “Return to Main Menu” (Figure 38) and press 1P START button to back to main menu (Figure 39).
6. Select “Return to Game” (Figure 39) and press 1P START button to back to game mode (Figure 35).
7. Press ESC key (Figure 28) to back to game list (Figure 29).
8. Some of games will appears the dialog window (Figure 30) after press ESC key (Figure 28), please select “Quit Game” item by 1P joystick and press 1P START button to back to game list (Figure 29).
9. Operate step 6 to 11 on page 13 for saving the game configuration setting (Figure 33).

Coin A	1 Coin/1 Credit
Coin B	1 Coin/1 Credit
2 Coins to Start, 1 to Continue	Off
Unused	Off
Difficulty	2
Free Play	Off
Freeze	Off
Flip Screen	Off
Demo Sounds	On
Allow Continue	No
Game Mode	Game
Return to Main Menu	

(Figure 37)

Coin A	1 Coin/1 Credit
Coin B	1 Coin/1 Credit
2 Coins to Start, 1 to Continue	Off
Unused	Off
Difficulty	6
Free Play	Off
Freeze	Off
Flip Screen	Off
Demo Sounds	Off
Allow Continue	Yes
Game Mode	Game
Return to Main Menu	

(Figure 38)

Input (general)
Input (this game)
Custom Buttons
Autofire Setting
Dip Switches
Bookkeeping Info
Game Information
Game Documents
Reset Game
Return to Game

(Figure 39)



(Figure 40)

Type 3: Special setting mode (Example: NAMCO SYSTEM 1 serial etc).

1. Switch ON bit 4 of SW2 (Figure 3).

twice to save modified configurations (Figure 33).

9. Select “Back to Main Menu” (Figure 32) and press 1P START button to back to “System Setting” (Figure 31).
10. Select “Exit” (Figure 31) and press 1P START button to back to game list (Figure 34).
11. Switch OFF bit 4 of SW2.

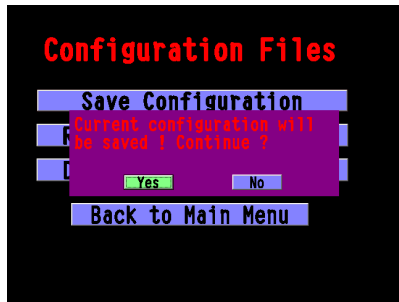

(Figure 33)



(Figure 34)

Type 2: Original setting is DIP SW setting mode. (Example: CAPCOM CPS1 serial etc).

1. Switch ON bit 4 of SW2 (Figure 3).
2. Select the game that will be set (Ex. Street fighter II’) and start the game (Figure 35).



(Figure 35)



(Figure 36)

3. Press ADJ2 key (Figure 28) and select “Dip Switches” by 1P joystick (Figure 36).
4. Press 1P START button to entry configuration setting menu

2. Keep system working at game list (Figure 5).
3. Press SETUP key (Figure 6) to entry “System Setting” menu (Figure 7).

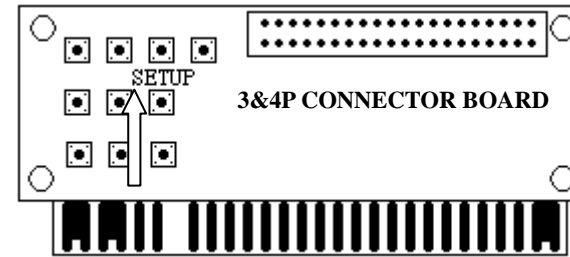

(Figure 6)

4. Select “Game List Setting” item by 1P joystick (Figure 7) and press 1P START button to entry “Game List Setting” menu (Figure 8).

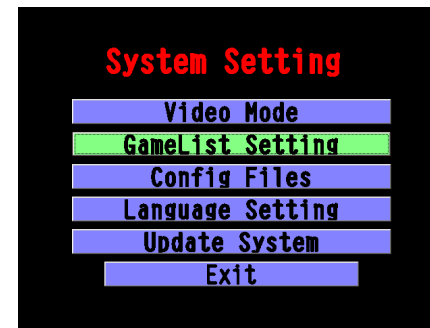

(Figure 7)



(Figure 8)

5. Select “Show/Hide Game list” item by 1P joystick (Figure 8).



(Figure 9)



(Figure 10)

6. Press 1P START button to entry “Show/Hide Game List” menu (Figure 9).

- Select game list item by 1P joystick and press 1P START button to decide show or hide. Dark square means show and light square stands for hide. After finish all game lists Show or Hide setting, select “Exit” (Figure 9) and press 1P START button to back to “Game List Setting” menu (Figure 10).



(Figure 11)



(Figure 12)

*** SAVE MODIFIED GAME LIST***

- Select “Save Current Game List” item (Figure 10) and press 1P START button twice to save game list (Figure 11).
- Select “Back to Main Menu” (Figure 12) and press 1P START button to back to “System Setting” menu (Figure 13).

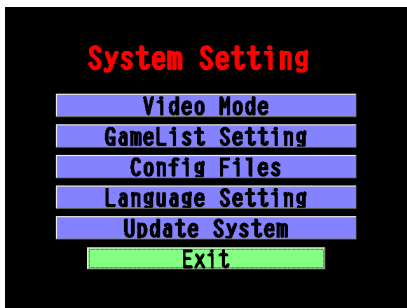

(Figure 13)



(Figure 14)

- Select “Exit” (Figure 13) and press 1P START button to back to game list (Figure 14).
- Switch OFF bit 4 of SW2.

- Some of games will appears the dialog window (Figure 30) after press ESC key (Figure 28), please select “Quit Game” item by 1P joystick and press 1P START button to back to game list (Figure 29).



(Figure 29)

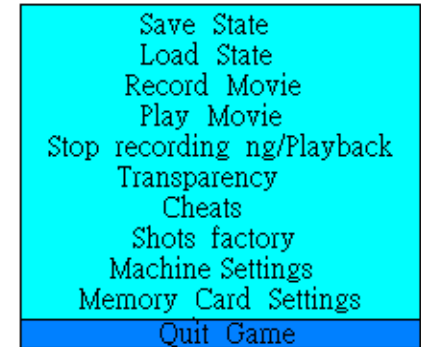

(Figure 30)

SAVE MODIFIED GAME CONFIGURATION SETTING

- Press SETUP key (Figure 28) to entry “System Setting” mode (Figure 31).
- Select “Config Files” item (Figure 31) and press 1P START key to entry “Config Files” menu (Figure 32).

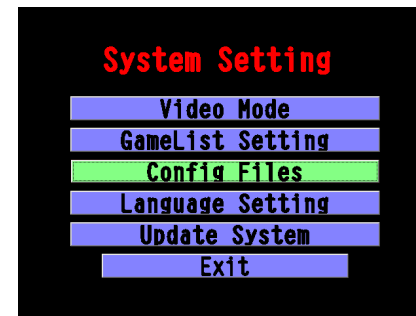

(Figure 31)

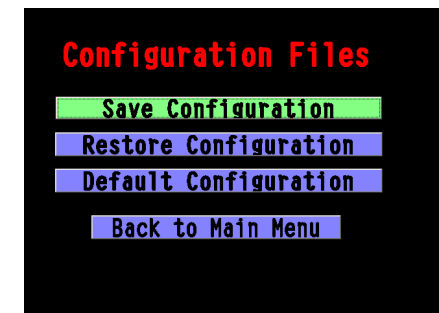

(Figure 32)

- Select “Save Configuration” item (Figure 32) and press 1P START

NEW GAMES UPDATE:

About new game update information please ask to vender. We'll deliver new games and tools to all of our venders when new games announce.

GAME CONFIGURATION SETTING:

Type 1: Original setting is on screen setting mode.

(Example: SNK NEO GEO, CAPCOM CPSII serial etc).

1. Switch ON bit 4 of SW2 (Figure 3).
2. Select the game that will be set (Ex. Metal Slug 3) and start the game (Figure 26).

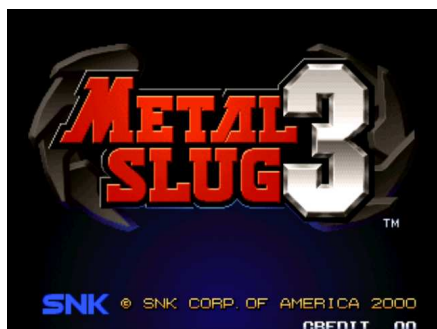

(Figure 26)

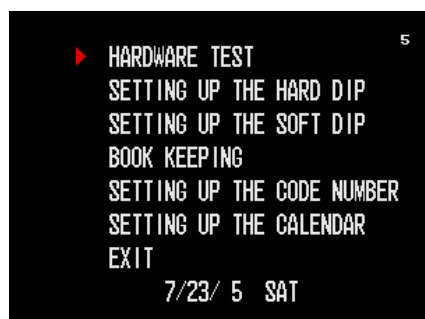

(Figure 27)

3. Press ADJ1 key (Figure 28) to entry the game original setting mode (Figure 27).

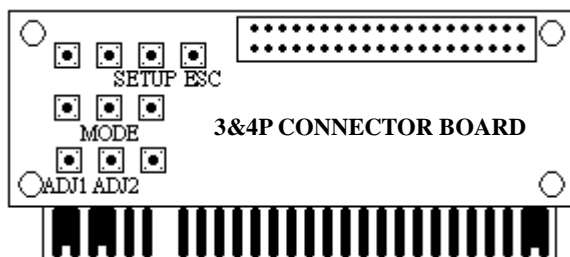

(Figure 28)

4. After finished the game setting and exited to the game mode (Figure 26), press ESC key (Figure 28) to back to game list (Figure 29).

Note:

1. Working list can't be hidet.
2. "Restore Game List" (Figure 12) means to get back the older game list.
3. "Restore Default Game List" (Figure 12) means to retrieve to factory game list setting.

ONE GAME BUSINESS MODE:

1. Select a favorite game and entry to game mode.
2. Switch on SW2 bit 3 (Figure 15).
3. "Escape to game menu" function will be disabled.

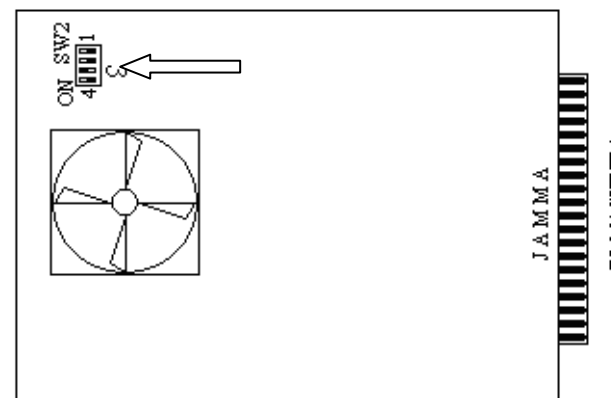

(Figure 15)

DELETE GAME FROM GAME LIST

1. Switch ON bit 4 of SW2 (Figure 3).
2. Select the game name that will be deleted at game list (Figure 16) and press DEL key (Figure 18). The game will disappear from game list (Figure 17).



(Figure 16)



(Figure 17)

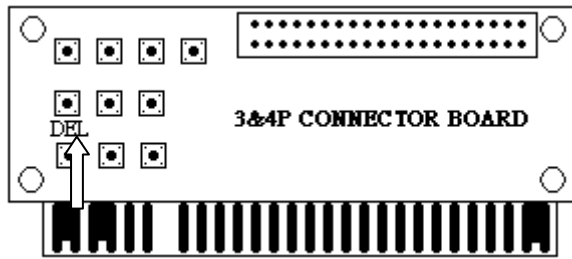

(Figure 18)

2. Press SETUP key (Figure 6) to entry “System Setting” menu (Figure 7).
3. Select “Game List Setting” item (Figure 7) and press 1P SART button to entry “Game List Setting” menu (Figure 10).
4. Execute step 6 to 9 operations on page 8.

ADD GAMES FROM ALL GAME LIST TO ONE OF GAME LISTS

1. Switch ON bit 4 of SW2 (Figure 3).
2. Press LIST key (Figure 19) to entry game lists menu (Figure 20).
3. Select “All Games” and press 1P START button to entry “All” game list (Figure 21).
4. Select a favorite game (Figure 21) and press “ADD” key (Figure 19) to entry game lists menu (Figure 22).
5. Select a destination game list and press 1P START button (Figure 22). The game will be added to the game list (Figure 23).
6. Press SETUP key (Figure 6) to entry “System Setting” menu (Figure 7).
7. Select “Game List Setting” item (Figure 7) and press 1P SART button to entry “Game List Setting” menu (Figure 10).
8. Execute step 6 to 9 operations on page 8.

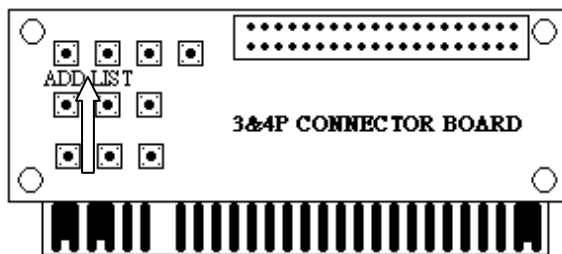

(Figure 19)



(Figure 20)



(Figure 21)



(Figure 22)



(Figure 23)

LANGUAGE SETTING:

1. Switch ON bit 4 of SW2 (Figure 3).
2. Press SETUP key (Figure 6) and select “Language Setting” item (Figure 24).
3. Press 1P START button to change language from English to simple Chinese or simple Chinese to English (Figure 24, Figure 25).
4. Switch OFF bit 4 of SW2.

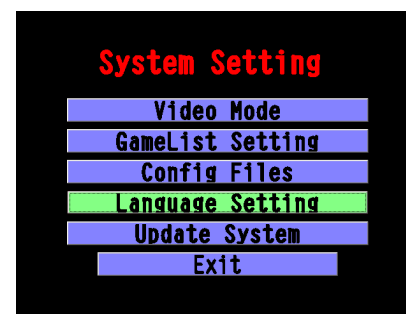

(Figure 24)

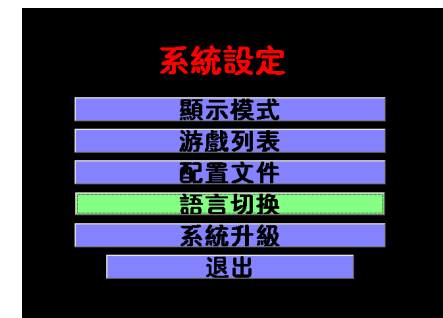

(Figure 25)